

Turmdrehkran

Tower Crane / Grue à tour / Gru a torre
Grúa torre / Guindaste de torre

56 K

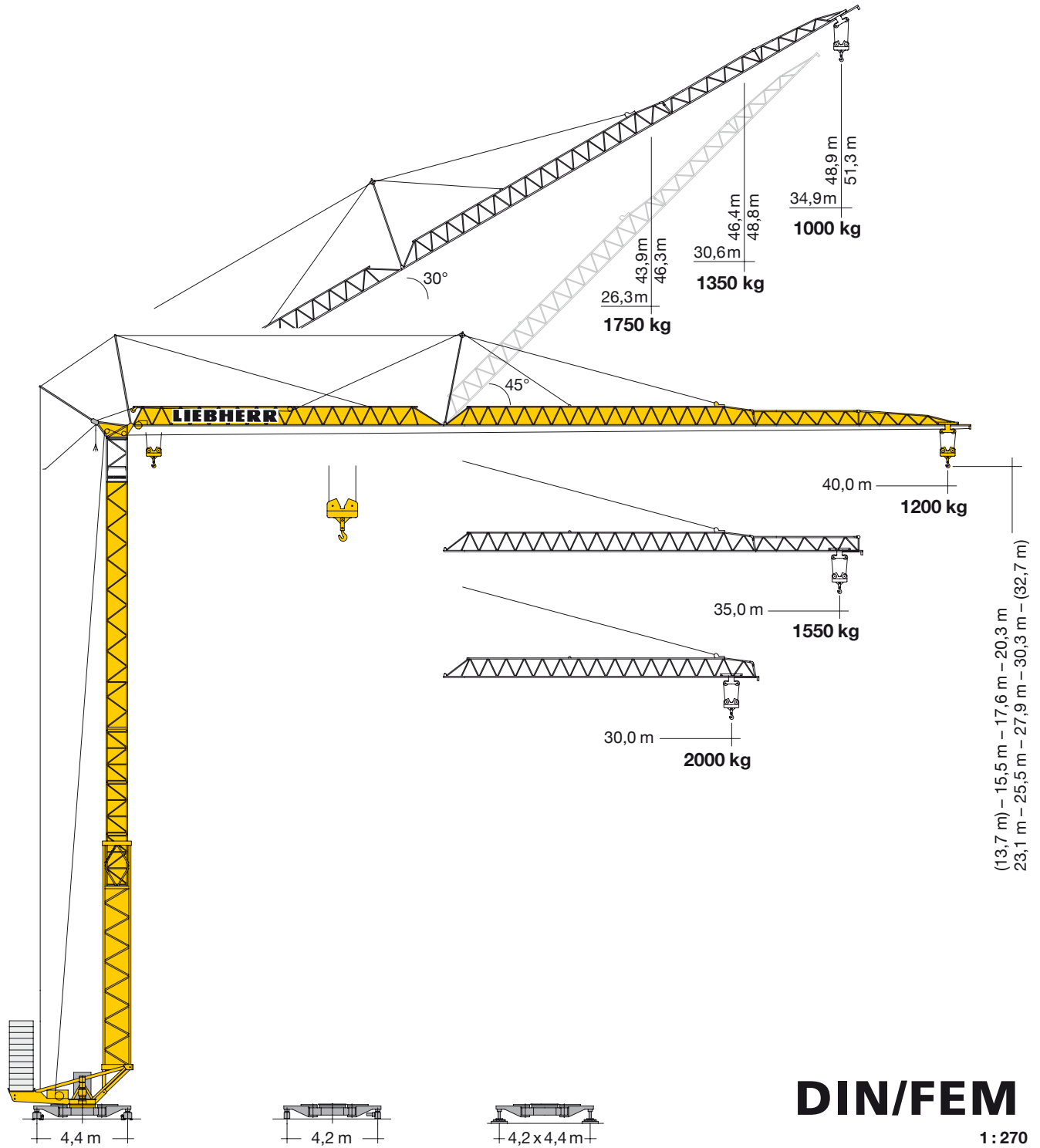

LIEBHERR

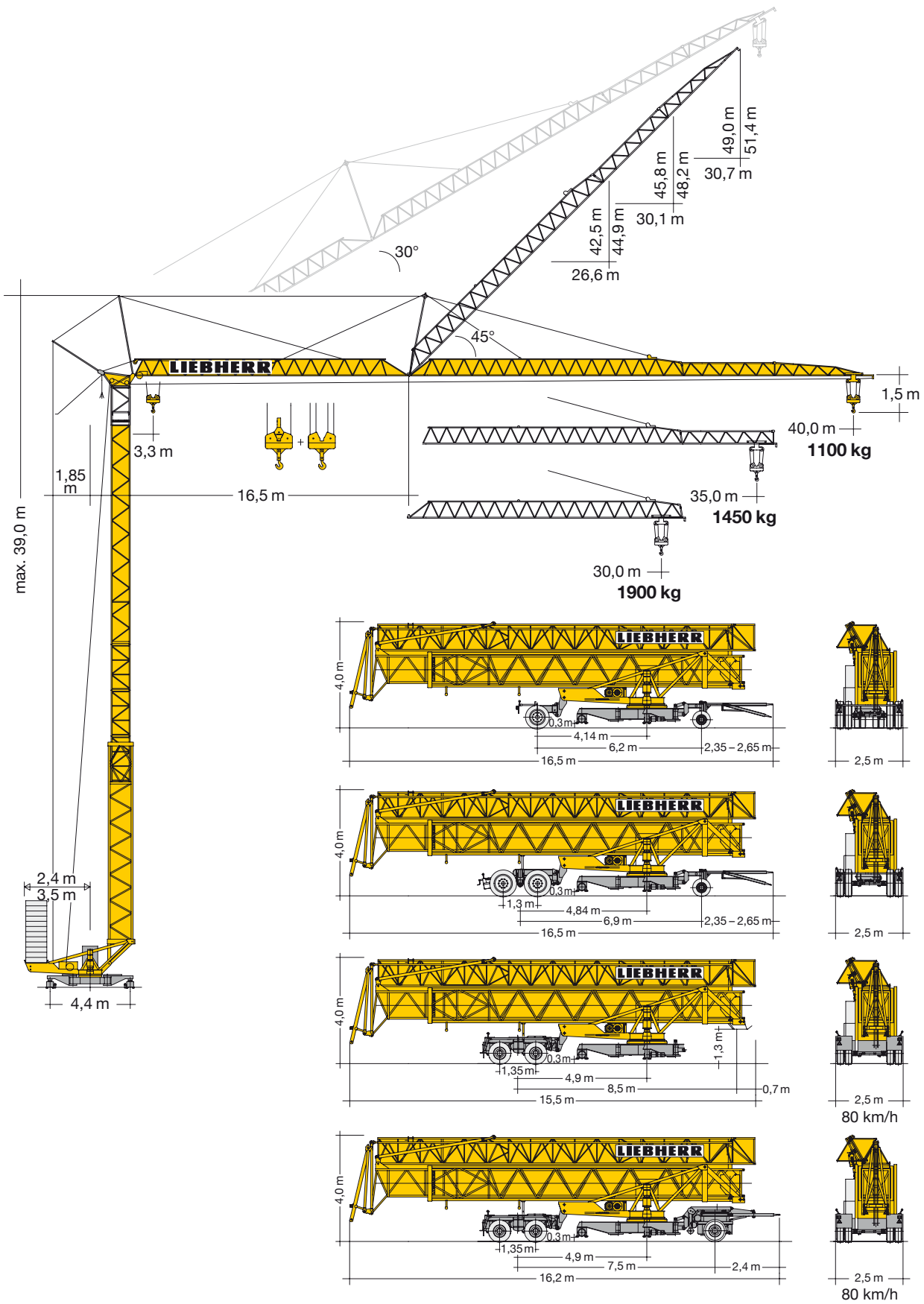

Gewicht

Weight / Poids / Peso / Peso / Pesos

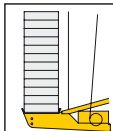



r = 3,5 m 21960 kg
r = 2,4 m 31110 kg



17500 kg

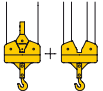



m	m/kg		m/kg																				
			20,0	21,0	22,0	23,0	24,0	25,0	26,0	27,0	28,0	29,0	30,0	31,0	32,0	33,0	34,0	35,0	36,0	37,0	38,0	39,0	40,0
40,0	3,3 – 23,6 2300		2300	2300	2300	2300	2250	2140	2040	1950	1870	1790	1720	1650	1590	1530	1470	1420	1370	1320	1280	1240	1200
35,0	3,3 – 25,3 2300		2300	2300	2300	2300	2300	2300	2220	2130	2030	1950	1870	1800	1730	1670	1610	1550					
30,0	3,3 – 26,7 2300		2300	2300	2300	2300	2300	2300	2300	2270	2170	2080	2000										

m	m/kg		m/kg																				
			20,0	21,0	22,0	23,0	24,0	25,0	26,0	27,0	28,0	29,0	30,0	31,0	32,0	33,0	34,0	35,0	36,0	37,0	38,0	39,0	40,0
40,0	3,3 – 23,9 2250	- 13,2 4500	2660	2500	2360	2230	2120	2010	1920	1830	1750	1670	1600	1530	1470	1420	1360	1310	1260	1220	1180	1140	1100
35,0	3,3 – 25,7 2250	- 14,1 4500	2920	2750	2590	2450	2330	2210	2110	2010	1920	1840	1760	1690	1630	1560	1510	1450					
30,0	3,3 – 27,2 2250	- 14,9 4500	3130	2950	2790	2640	2500	2380	2270	2170	2070	1980	1900										

m	m/kg		Auslegersteilstellung 30° / Elevated jib 30° / Flèche inclinée 30° Braccio inclinato a 30° / Pluma inclinada 30° / Lança inclinada 30°																				
			16,0	17,0	18,0	19,0	20,0	21,0	22,0	23,0	24,0	25,0	26,3	27,0	28,0	29,0	30,0	30,6	31,0	32,0	33,0	34,0	34,9
40,0	3,1 – 18,1 2300		2300	2300	2300	2170	2030	1910	1800	1710	1620	1540	1440	1390	1330	1270	1220	1190	1170	1120	1080	1040	1000
35,0	3,1 – 20,0 2300		2300	2300	2300	2300	2290	2160	2040	1930	1830	1740	1630	1580	1510	1450	1380	1350					
30,0	3,1 – 21,1 2300		2300	2300	2300	2300	2300	2300	2180	2070	1960	1860	1750										

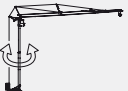
Antriebe

Driving units / Mécanismes d'entraînement / Azionamenti / Mecanismos / Mecanismos

	U/min. 0 ↔ 0,8 sl./min tr./min	5,0 kW EDC
	8,0 / 30,0 / 60,0 m/min 0 – 60,0 m/min	0,7 / 2,3 / 2,3 kW KL 2,8 kW FU
	25,0 m/min	2 x 1,5 kW
	0 – 45°, 60 sec.	3,0 kW

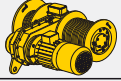
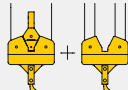
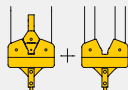
	Stufe / Step / Cran Marcia / Velocidad Velocidade	kg	m/min	
			kg	m/min
15,0 kW 	1	2250 4500	6,0 3,0	
	2	2250 4500	27,0 13,5	
	3	1600 3200	50,0 25,0	
11,0 kW FU 	1	2250 4500	4,7 2,4	
	2	2250 4500	24,0 12,0	
	3	1300 2600	45,0 22,0	
	4	900 1800	60,0 30,0	

BGL	 C.0.08.0056	 C.0.08.0050
-----	---	---

	400 V	Hz	kVA
99,0 m	4 x 10 mm ² KL 4 x 6 mm ² FU	50	28,0 KL 17,0 FU

- ④ **stationär**
4 Turmstücke
 stationary
 4 tower sections
 stationnaire
 4 éléments de mât
 stazionaria con
 4 elementi di torre
 estacionaria
 4 tramos de torre
 Estacionária
 4 tramos de torre
- ③ **schienenfahrbär**
3 Turmstücke
 rail-going
 3 tower sections
 mobile
 3 éléments de mât
 traslante con
 3 elementi di torre
 móvil 3 tramos
 de torre
 Móvel 3 tramos
 de torre
- ② **stationär**
ohne Turmstück
 stationary without
 tower section
 stationnaire sans
 éléments de mât
 stazionaria senza
 elementi di torre
 estacionaria sin
 tramo de torre
 Estacionária
 sem tramo de torre
- ① **schienenfahrbär**
ohne Turmstück
 rail-going without
 tower section
 mobile sans
 éléments de mât
 traslante senza
 elementi di torre
 móvil sin tramo
 de torre
 Móvel sem
 tramo de torre

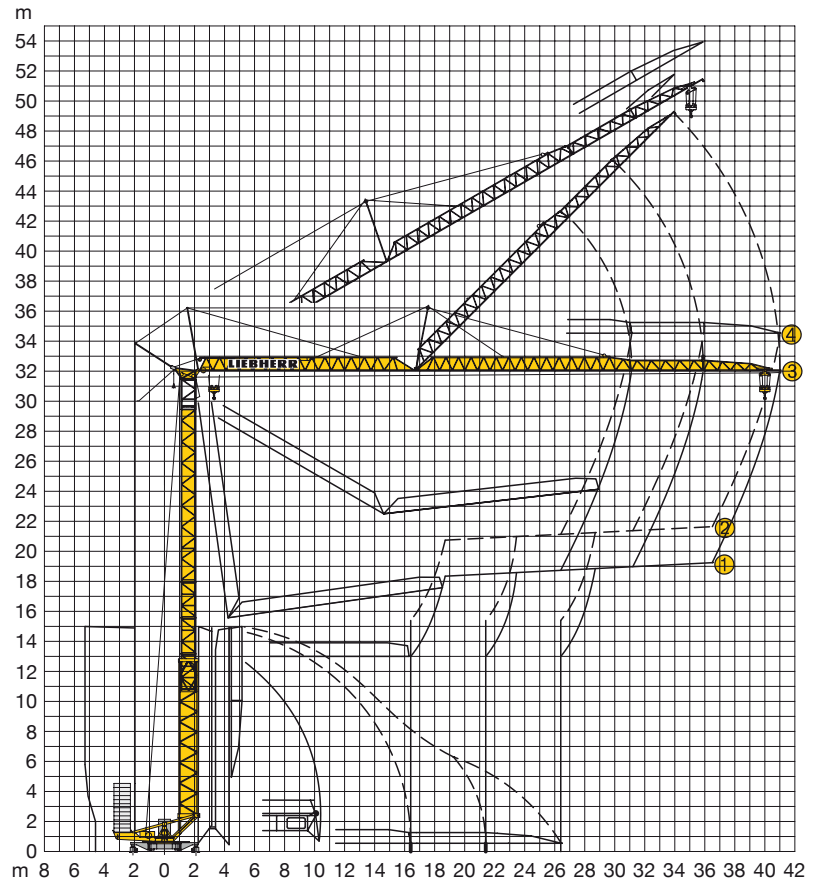

Kolli-Liste

Packing List / Liste de colisage / Lista dei colli / Lista de contenido / Lista de embalagem

Pos. Ref.	Anz. Qty.	Item Voce		L (m)	B (m)	H (m)	kg
1	3	Turmstück (ohne/mit Turmauflage*) / Tower section (without/with tower support*) / Élément de mât (sans/avec support de mât*) / Elemento di torre (senza/con pedana di servizio*) / Tramo de torre (sin/con soporte de torre*) / Tramo de torre (sem/com suporte de torre*)		2,50	1,10	1,10	450
2	1*			2,50	1,10	1,10	550*
3	1	Ausleger-Verlängerung 30,0 m – 35,0 m Jib extension / Rallonge de la flèche Elemento estensione braccio Prolongación de pluma / Extensão da lança		5,00	1,02	0,80	185
4	1	Ausleger-Verlängerung 35,0 m – 40,0 m Jib extension / Rallonge de la flèche Elemento estensione braccio Prolongación de pluma / Extensão da lança		5,10	1,02	0,70	130
5	1	Transportachse vorne Tra 100 KY 2 Road transport axle front / Essieux de transport avant / Asse di trasporto anteriore / Eje delantero para transporte / Eixo de transporte dianteiro		3,60	1,45	1,05	920
6	1	Transportachse hinten Tra 120 GY 1 Road transport axle behind / Essieux de transport arrière / Asse di trasporto posteriore / Eje trasero para transporte / Eixo de transporte traseiro		1,62	2,50	1,05	1075
7	1	Transportachse Tra 200 GZ 3 / Road transport axle Essieux de transport / Assali par trasporto Eje de transporte / Eixo de transporte		3,10	2,50	1,10	2500
8	1	Transportachse hinten Tra 203 Road transport axle behind / Essieux de transport arrière / Asse di trasporto posteriore / Eje trasero para transporte / Eixo de transporte traseiro		3,00	2,50	1,20	2500
9	1	Transportachse vorne Tra 115 Road transport axle front / Essieux de transport avant / Asse di trasporto anteriore / Eje delantero para transporte / Eixo de transporte dianteiro		3,80	2,50	1,28	1900
10	1	Kiste mit Seilen und Kleinteilen / Case with ropes and small parts Caisse avec câbles et pièces détachées / Cassa con funi e accessori Caja con cables y piezas sueltas / Caixa contendo cabos e acessórios		1,00	0,80	1,00	450

Konstruktionsänderungen vorbehalten!
 Subject to alterations! / Sous réserves de modifications!
 Si fa riserva di modifiche! / Salvo modificão da construoão!
 ¡Sujeto a modificaciones!

Sämtliche Angaben erfolgen ohne Gewähr. / This information is supplied without liability.
 Ces renseignements sont sans garantie. / Le indicazioni contenute si intendono salvo errori ed omissioni.
 Declinamos toda responsabilidad derivada de la información proporcionada. / Declinamos qualquer
 responsabilidade quanto à informação fornecida.