

- 1.7x1.7  
SK1700
- 1.2x1.2  
SG1200

FEM	Hg (m)		FEM	Hg (m)	
	○	□		○	□
CATR	24.7	23.9	CATR	51.7	50.9
CAF	30	29.2	CAF	54.9	54.1
TEF	29.6	28.8	TEF	58.8	58
TRF	29.5	28.7	TRF	58	57.2

C25		○	□
CATR	51.7	50.9	
CAF	51	50.2	
TEF	54.9	54.1	
TRF	54.1	53.3	

D25		○	□
CATR	43.9	43.1	
CAF	43.2	42.4	
TEF	51	50.2	
TRF	50.2	49.4	

- ①
- CATR
- CATC
- CAF
- TEF
- TRF
- PRT-TR
- PRT

Power Control

ASsys

ACsys

FEM 1.001 - A4  
EN 14439 - C25 - D25

Torre/Reazioni – Masts/Reactions – Mat/Réactions – Maste/Eckdrücke – Măstil/Reacciones – Tramo/Reacções

SG1200 FEM

○ Hg=Ht-1 m  
 □ Hg=Ht-1.8 m

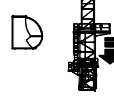
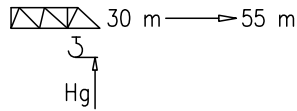

4	B0120	2/3
3	B0060	2/3
2	ST030	3/3
1	ST060	3/3

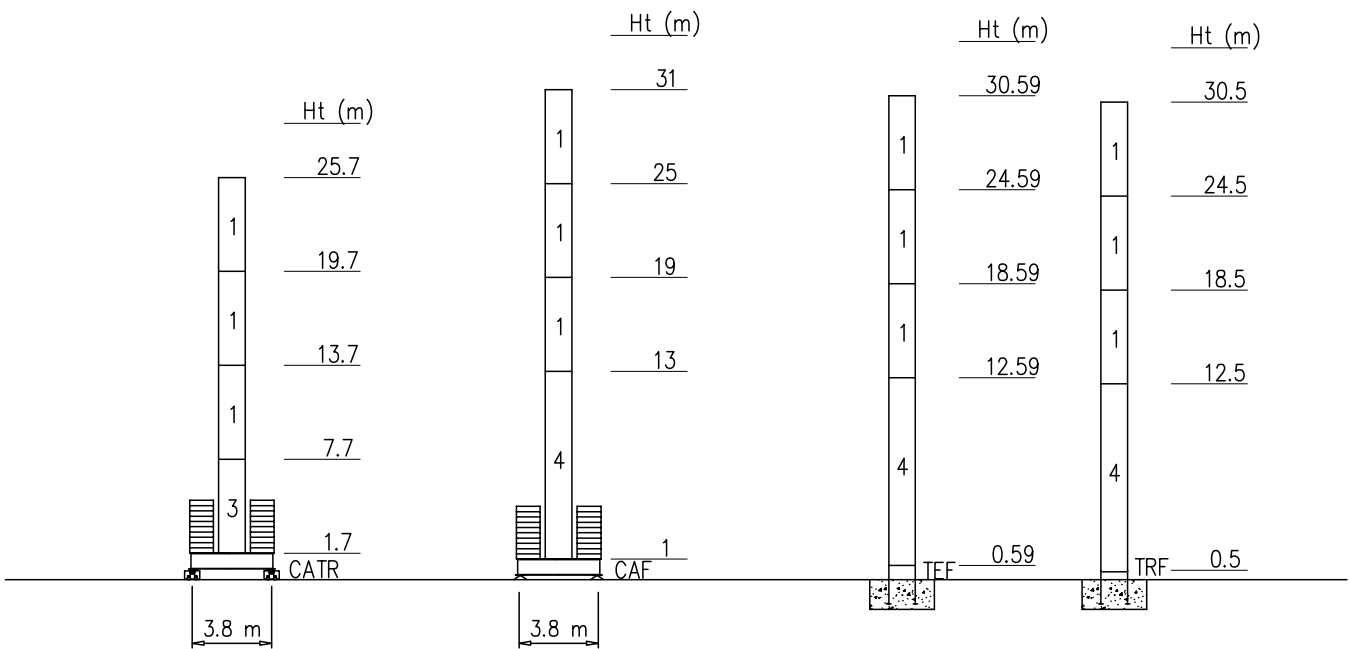

Peso zavorra – Ballast weight – Poids du lest – Ballastgewicht – Peso de lastre

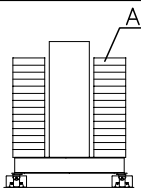

SG1200				
H-CATR (m)	16.7	19.7	25.7	
FEM (t)	54	60	72	
n°	18xA	20xA	24xA	

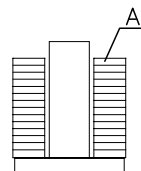
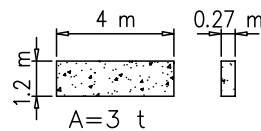

SG1200				
H-CAF (m)	16	19	31	
FEM (t)	54	60	72	
n°	18xA	20xA	24xA	

Torre/Reazioni – Masts/Reactions – Mat/Réactions – Maste/Eckdrücke – Mästil/Reacciones – Tramo/Reacções

SK1700 FEM

○ Hg=Ht-1 m  
 □ Hg=Ht-1.8 m

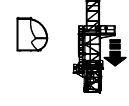
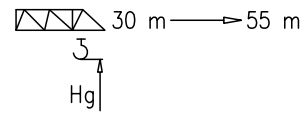

4	BPF039	4/4
3	ST117	2/2
2	BAF117	4/2
1	ST039	2/2

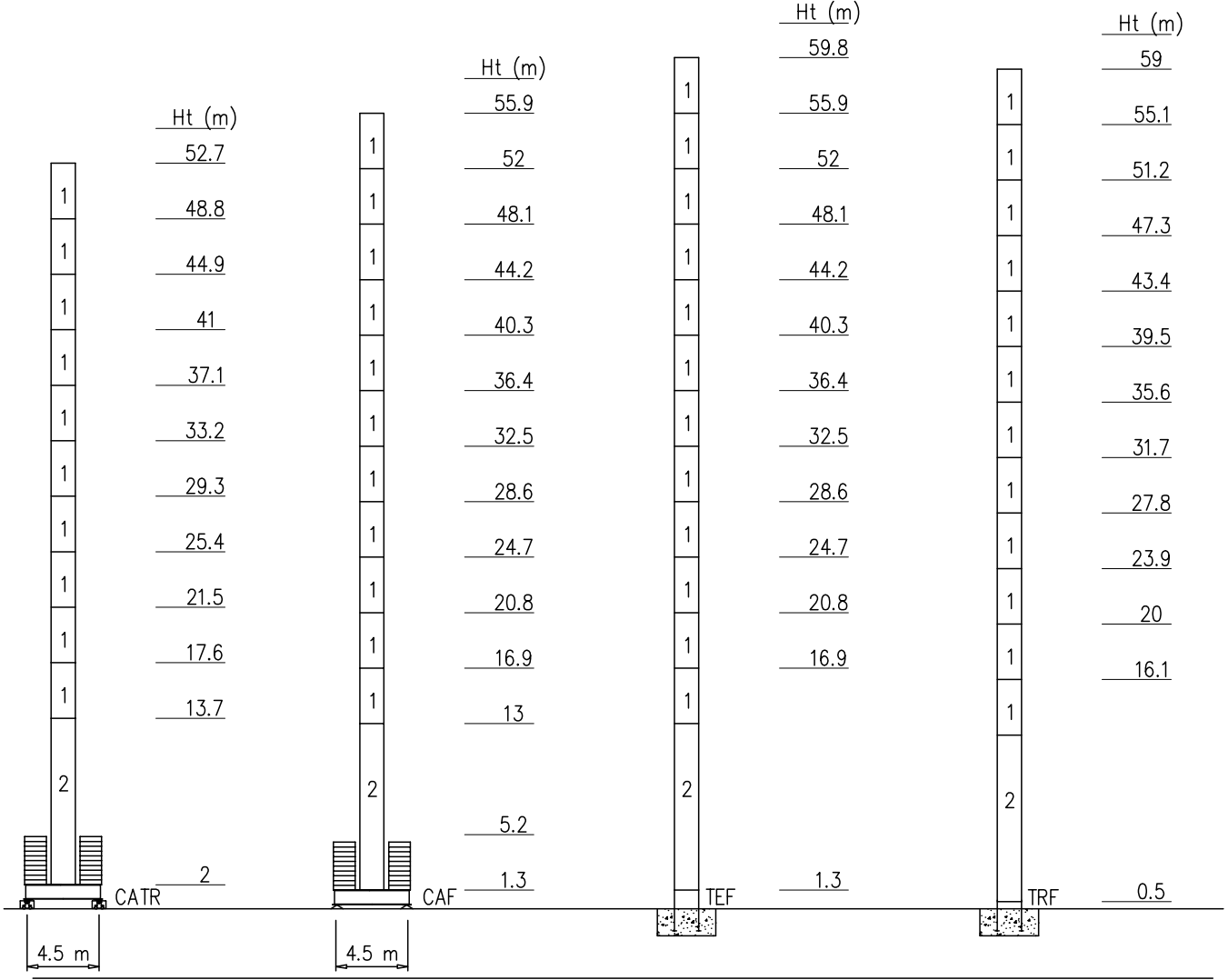

Peso zavorra – Ballast weight – Poids du lest – Ballastgewicht – Peso de lastre

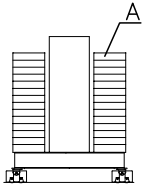

SK1700			
H-CATR (m)	37.1	48.8	52.7
FEM (t)	70	112	126
n°	20xA	32xA	36xA

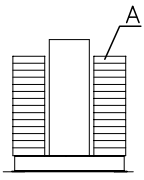
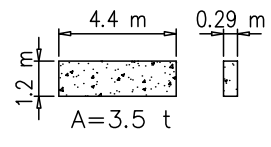

SK1700									
H-CAF (m)	24.7	28.6	32.5	36.4	40.3	44.2	48.1	52	55.9
FEM (t)	63	63	63	63	77	84	105	126	126
n°	18xA	18xA	18xA	18xA	22xA	24xA	30xA	36xA	36xA

Torre/Reazioni – Masts/Reactions – Mat/Réactions – Maste/Eckdrücke – Măstil/Reacciones – Tramo/Reacções

SK1700 EN14439-C25

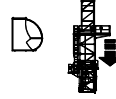
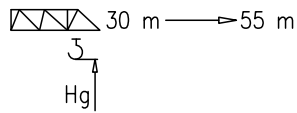

4	BPF039	4/4
3	ST117	2/2
2	BAF117	4/2
1	ST039	2/2

- Hg=Ht-1 m
- Hg=Ht-1.8 m

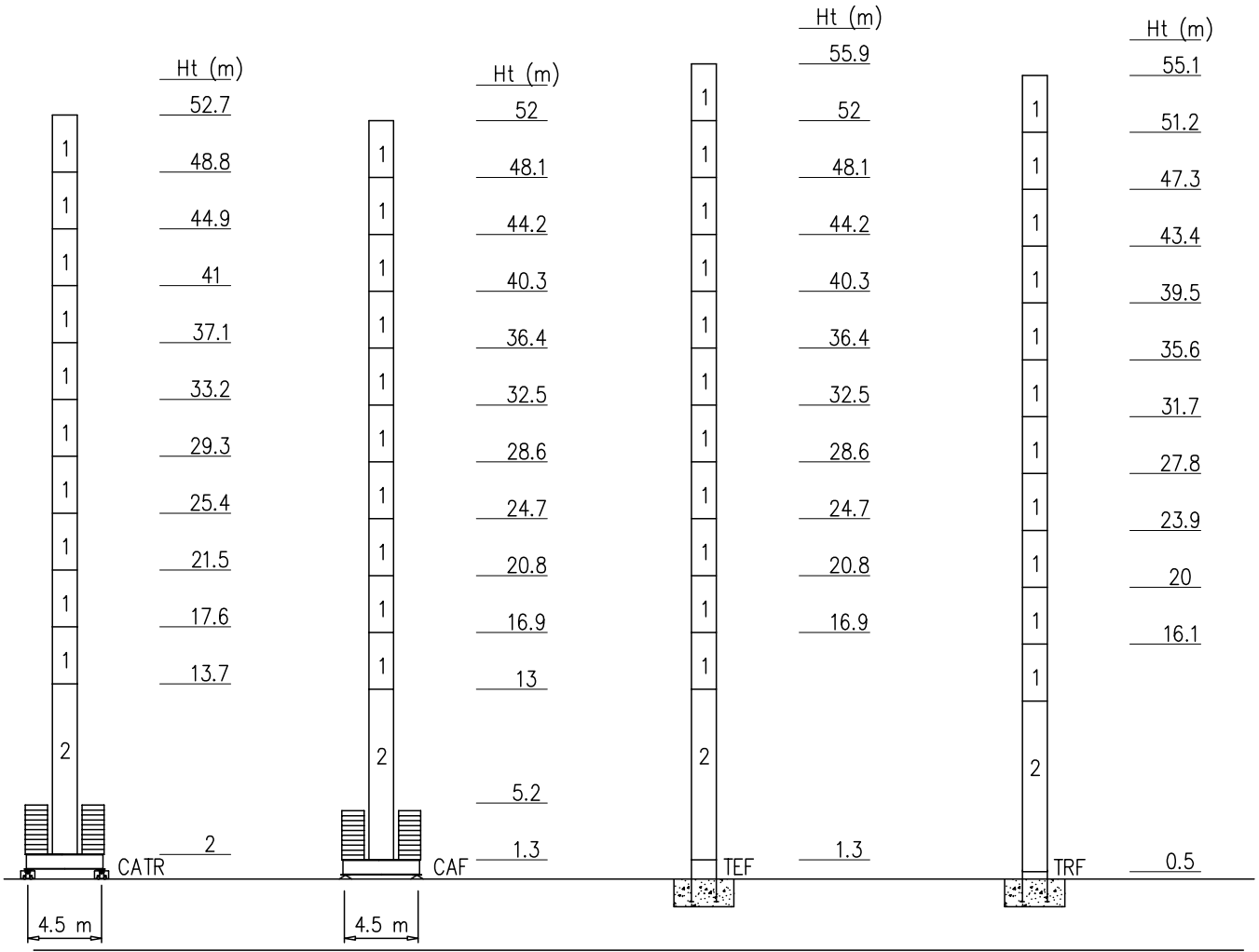

Peso zavorra – Ballast weight – Poids du lest – Ballastgewicht – Peso de lastre

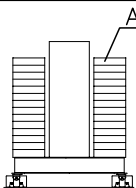

SK1700			
H-CATR (m)	37.1	48.8	52.7
(t)	70	119	126
n°	20xA	34xA	36xA

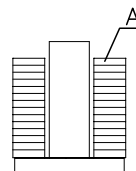
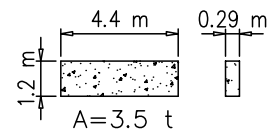

SK1700								
H-CAF (m)	24.7	28.6	32.5	36.4	40.3	44.2	48.1	52
(t)	63	63	63	63	84	98	112	126
n°	18xA	18xA	18xA	18xA	24xA	28xA	32xA	36xA

Torre/Reazioni – Masts/Reactions – Mat/Réactions – Maste/Eckdrücke – Măstil/Reacciones – Tramo/Reacções

SK1700 EN14439-D25

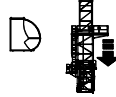
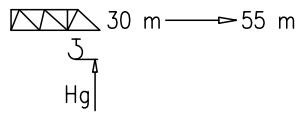

4	BPF039	4/4
3	ST117	2/2
2	BAF117	4/2
1	ST039	2/2

- Hg=Ht-1 m
- Hg=Ht-1.8 m

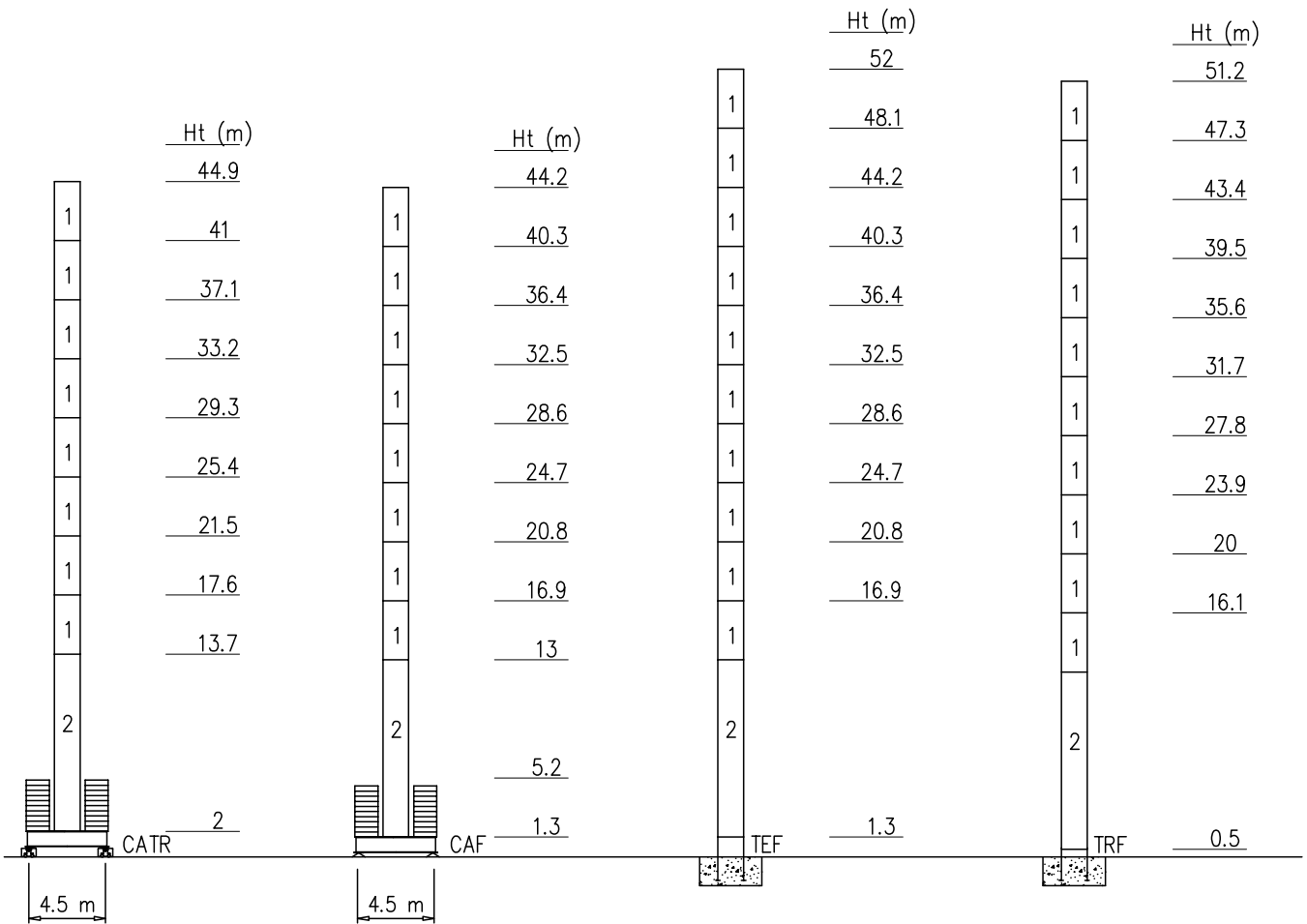

Peso zavorra – Ballast weight – Poids du lest – Ballastgewicht – Peso de lastre

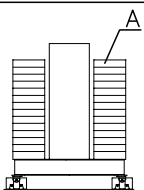

SK1700			
H-CATR (m)	33.2	44.9	
(t)	70	126	
n°	20xA	36xA	

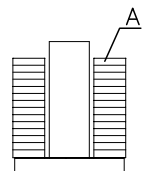
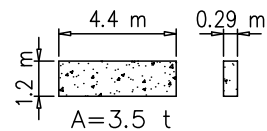

SK1700						
H-CAF (m)	24.7	28.6	32.5	36.4	40.3	44.2
(t)	63	63	63	63	84	119
n°	18xA	18xA	18xA	18xA	24xA	34xA

Curve di carico – Courbes de charges – Load diagrams – LastKurven – Curvas de cargas

Pmax 3000 kg

	16800 kg		2	29.5	32.5	35	37.5	40	42.5	45	47.5	50	52.5	55	m
		55 m	<b>3000</b>	3000	2750	2510	2310	2120	1970	1850	1690	1580	1450	1300	kg
	15600 kg		2	30.9	32.5	35	37.5	40	42.5	45	47.5	50			m
		50 m	<b>3000</b>	3000	2960	2700	2480	2290	2120	1970	1830	1600			kg
	14400 kg		2		32.8	35	37.5	40	42.5	45					m
		45 m	<b>3000</b>		3000	2940	2720	2500	2300	2000					kg
	13200 kg		2				35.7	40							m
		40 m	<b>3000</b>				3000	2600							kg
	12000 kg		2				35								m
		35 m	<b>3000</b>				3000								kg
	12000 kg		2			30									m
		30 m	<b>3000</b>			3000									kg









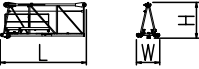

Pmax 6000/3000 kg

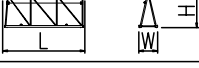

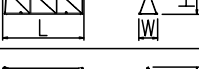
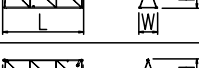
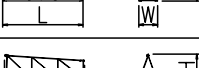
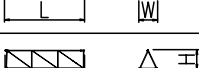
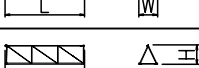
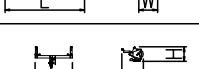

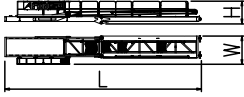
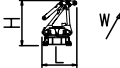
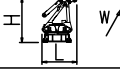
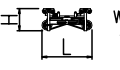
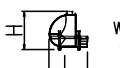





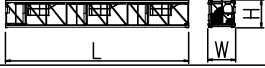
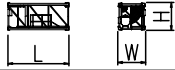
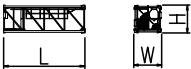

	16800 kg		2	16.7	17.5	20	22.5	25	27.5	30	32.5	35	37.5	40	42.5	45	47.5	50	52.5	55	m
		55 m	<b>6000</b>	6000	5640	4850	4250	3760	3370	3000	2750	2510	2310	2120	1970	1850	1690	1580	1450	1300	kg
	15600 kg		2		17.5	20	22.5	25	27.5	30	32.5	35	37.5	40	42.5	45	47.5	50			m
		50 m	<b>6000</b>		6000	5200	4550	4030	3610	3250	2960	2700	2480	2290	2120	1970	1830	1600			kg
	14400 kg		2		18.4	20	22.5	25	27.5	30	32.5	35	37.5	40	42.5	45					m
		45 m	<b>6000</b>		6000	5600	4920	4350	3900	3530	3210	2940	2720	2500	2300	2000					kg
	13200 kg		2			20	22.5	25	27.5	30	32.5	35	37.5	40							m
		40 m	<b>6000</b>			6000	5480	4860	4370	3950	3600	3300	3000	2600							kg
	12000 kg		2				19.6	25	27.5	30	32.5	35									m
		35 m	<b>6000</b>				6000	5250	4740	4260	3900	3000									kg
	12000 kg		2				21.2	25	27.5	30											m
		30 m	<b>6000</b>				6000	5700	5000	4000											kg

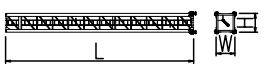

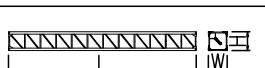
PESI E INGOMBRI – PACKING LIST – LISTE DE COLISAGE – GEWICHT UND ABMESSUNGEN

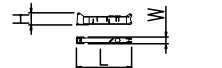
Denominazione Description	Disegno Draw	Pezzi Pieces	Dimensioni-Dimensions (mm)			Peso-Weight (kg)			
			L	W	H	Unit	Total		
Elemento di braccio Jib element Elément de èche Elemento de flecha	n°11		1	5500	1480	2290	1500	–	
	n°10		1	5260	1200	2150	980	–	
	n°9		1	5260	1200	2120	800	–	
	n°8		1	5240	1200	2100	700	–	
	n°7		1	5225	1200	2060	635	–	
	n°6		1	5200	1200	1630	500	–	
	n°5		1	5160	1200	1630	370	–	
	n°4		1	5140	1200	1610	350	–	
	n°3		1	5110	1200	1610	250	–	
	n°2		1	5090	1200	1260	210	–	
	n°1		1	5090	1200	1260	200	–	
	Punta braccio		1	700	1200	500	55	–	
Controbraccio completo Complete counterjib Contreflèche complète Contraflecha completa		1	10660	1750	1480	2900	–		
Gruppo girevole Slewing group Table tournante Grupo giratorio	SK1700		1	2300	1810	2900	5900	–	
	S1200		1	2450	1810	2900	3500	–	
Carrello Trolley Chariot Carretilla	P6		1	1600	1620	710	320	–	
Ballatoio con cabina Access balcony with cabin Porte cabine Balcòn corrido con cabina		1	2500	2150	2450	1000	–		
Blocchi contrappeso Counterweight block Contre-poids Bloques de contrapeso	VX24		VS12	2	1000	200	2500	1200	2400
	VS12			VX24	6	1000	400	2500	2400

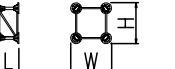
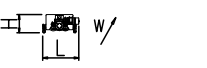
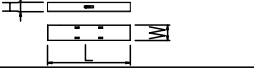
PESI E INGOMBRI – PACKING LIST – LISTE DE COLISAGE – GEWICHT UND ABMESSUNGEN

Denominazione Description	Disegno Draw	Pezzi Pieces	Dimensioni-Dimensions (mm)			Peso-Weight (kg)		
			L	W	H	Unit	Total	
Elemento di torre Mast element Elément de mature Elemento de torre	BAF117 	SK1700	–	11700	1785	1785	4690	–
	ST039 BPF039 	SK1700	–	3900	1785	1785	1750 2350	–
	ST052 	SK1700	–	5200	1785	1785	2250	–
	ST117 	SK1700	–	11700	1785	1785	4690	–
	BL060 	SG1200	–	6000	1440	1440	2162	–
	B0060 	SG1200	–	6000	1440	1440	2035	–
	B0120 	SG1200	–	12000	1440	1440	3670	–
	ST030 	SG1200	–	3000	1200	1200	934	–
	ST060 	SG1200	–	6000	1200	1200	1635	–
	ST120 	SG1200	–	12000	1200	1200	3060	–
Carro di base Base carriage Chassis de base Cruceta de base		3.8x3.8	1	5700	520	660	2280	2280
		4.5x4.5	1	6670	500	1260	3180	3180
		3.8x3.8	2	2700	340	660	1090	2180
		4.5x4.5	2	3100	500	1260	1400	2800
Elemento a perdere Disposable frame Chassis a perdre Bastidor desechable		SG1200	1	1990	1440	1440	1150	–
		SK1700	1	1840	1910	1910	1430	–
Elemento recuperabile Recoverable frame Chassis récupérable Bastidor recuperable		SG1200	1	600	1740	1740	940	–
		SK1700	1	1300	2170	2170	1720	–
Bogie di traslazione Driven bogie Boggie motorisèe Balancin de traslaciòn			4	1160	700	600	700	2800
Blocco zavorra di base Base ballast block Lest de base Bloque de lastre		3.8x3.8	–	4000	1200	270	3000	–
		4.5x4.5	–	4400	1200	290	3500	–
Corsoio di montaggio Climbing cage Cage de montage Jaula de montaje		SG1200	1	8300	1600	1500	3000	–
		SK1700	1	8300	2600	2500	6000	–



GRU IN CAVEDIO – TELESCOPAGE SUR DALLES – CLIMBING CRANE – KLETTERKRANE IM GEBAUDE

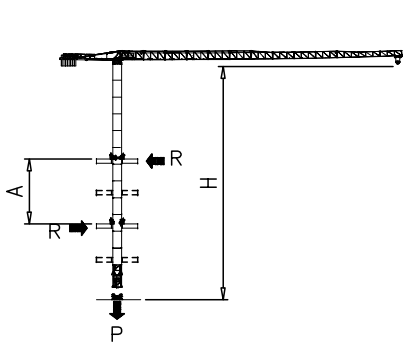

SK1700	H (m)	A (m)
	39	Min 9
Apertura passaggio gru Opening for crane passing 		Max 12

SG1200	H (m)	A (m)
	30	Min 6
Apertura passaggio gru Opening for crane passing 		Max 9

SOPRALZO IDRAULICO – TELESCOPABLE – EXTERNAL CLIMBING – KLETTERKRANE

FEM

SK1700		
MAX	C	32.5 m
	B	19.5 m
	A	46.8 m

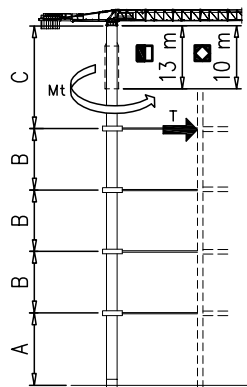

SG1200		
MAX	C	27 m
	B	17 m
	A	20.5 m

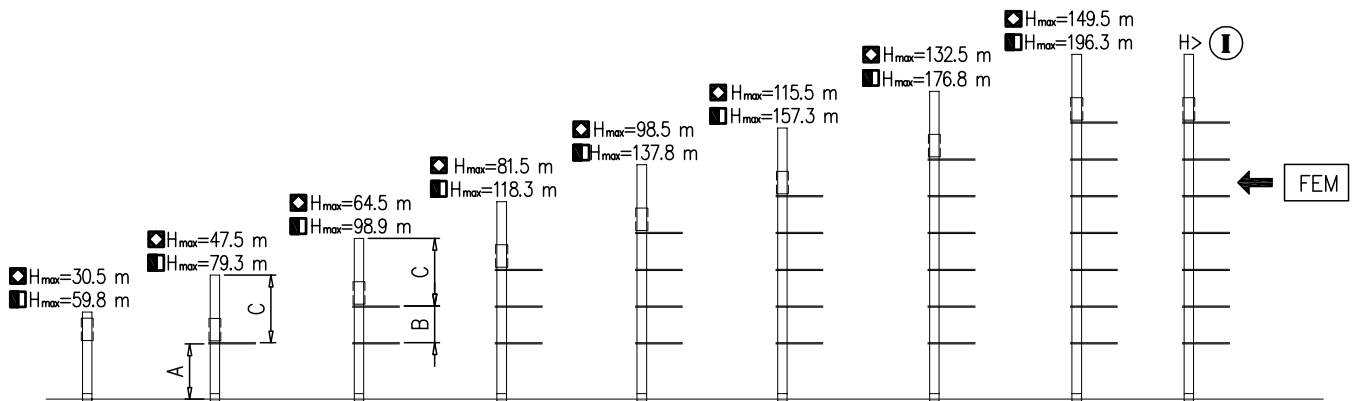

Montaggio – Montage – Erection – Montage – Montaje – Montagem

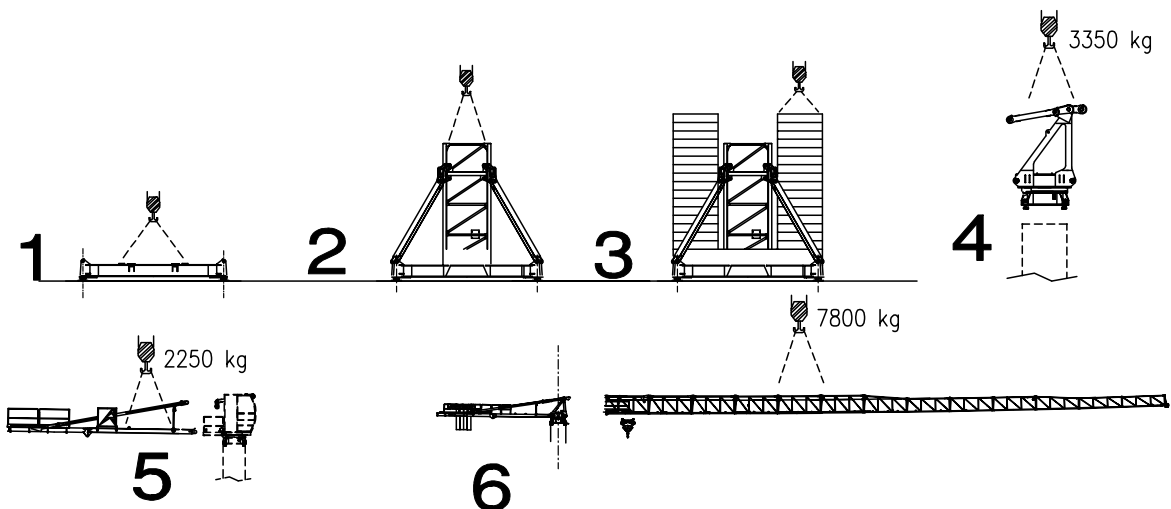

Meccanismi – Mechanisms – Mécanismes – Antriebe – Mecanismos

Sollevamento V25.60 Hoisting Levage Heben Elevaciòn Elevaçao														V25.60 18.4 kW 37 kVA  172 m 344 m (L)
	m/min	7	18	28	42	56	65	3.5	9	14	21	28	32.5	
	t	3	3	3	2.25	1.5	0.9	6	6	6	4.5	3	1.8	

Sollevamento V33.90 Hoisting Levage Heben Elevaciòn Elevaçao														V33.90 22 kW 47 kVA  380 m 760 m (L)
	m/min	3	18	34	54	70	90	1.5	9	17	27	35	45	
	t	3	3	3	1.8	1.3	0.5	6	6	6	3.6	2.6	1	

Sollevamento V45.120 Hoisting Levage Heben Elevaciòn Elevaçao														V45.120 33 kW 57 kVA  340 m 680 m (L)						
	m/min	4	18	40	64	90	120													
	t	3	3	3	1.9	1.1	0.6													

Carrello Trolleying Distribution Katzfahren Distribuciòn Distribuiçao			0 → 55	m/min	3 kW
--	--	--	--------	-------	------

Rotazione Slewing Orientation Schwenken Orientaciòn Rotaçao			0 → 0,9	giri/min tr/min rp/min	4.4 kW @ 1200rpm n° 2 x 2.2 kW
--	--	--	---------	------------------------------	-----------------------------------

Traslazione Travelling Translation Kranfahren Traslaciòn Traslaçao			0 → 20	m/min	3.7 kW
---	--	--	--------	-------	--------

Rete elettrica – Réseau – Mains supply – Netzstrom – Red – Rede electrica	400V – 50 Hz
---	--------------

FEM 1.001 – A4 EN 14439 – C25 – D25	
--	--

Potenza elettrica necessaria  
Puissance électrique nécessaire  
Necessary electric power  
Anschlusswert – Potencia