

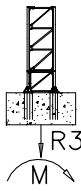
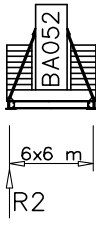

Torre/Reazioni – Masts/Reactions – Mat/Réactions – Maste/Eckdrücke – Mästil/Reacciones – Tramo/Reaçções

SN2050

 20 m \rightarrow 72.7 m

Torre/Masts/Mat/Maste/Mästil/Tramo															
	H[m]	4f/4f BF117	4f/4f BF052	4f/4f BF039	4f/2f SB117	4f/2f SB052	4f/2f SB039	2f/2f ST117	2f/2f ST052	2f/2f ST039	2f/2f STB117	2f/2f STB039	2f/2f RA039	4f/2f SBB039	4f/2f SBB117
TRO 	55.9	2			1			1	1	1					
	55.9	4				1			5	1					
TTD 	55.9	1	1	1			1			9					
	52	1	1		1			2							
	46.8	1			1			2							
	* 55.9	1	1									6	1		1
	* 55.9	4										7	1	1	
* 55.9	1	1	1								7	1	1		

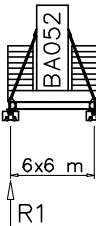
Torre/Masts/Mat/Maste/Mästil/Tramo															
	H[m]	4f/4f BF117	4f/4f BF052	4f/4f BF039	4f/2f SB117	4f/2f SB052	4f/2f SB039	2f/2f ST117	2f/2f ST052	2f/2f ST039	2f/2f STB117	2f/2f STB039	2f/2f RA039	4f/2f SBB039	4f/2f SBB117
CAF 	61.1	2			1			1	1	1					
	61.1	4				1			5	1					
	61.1	1	1	1			1			9					
	57.2	1	1		1			2							
	52	1			1			2							
	* 61.1	1	1									6	1		1
* 61.1	4										7	1	1		
* 61.1	1	1	1								7	1	1		

Torre/Masts/Mat/Maste/Mästil/Tramo															
	H[m]	4f/4f BF117	4f/4f BF052	4f/4f BF039	4f/2f SB117	4f/2f SB052	4f/2f SB039	2f/2f ST117	2f/2f ST052	2f/2f ST039	2f/2f STB117	2f/2f STB039	2f/2f RA039	4f/2f SBB039	4f/2f SBB117
CATR 	57.2				1			1	1						
	57.2	4				1		5							
	57.2		1	1			1			8					
CATC 	57.2		1		1			2							
	* 57.2		1									5	1		
	* 57.2	4										6	1	1	
	* 57.2		1	1								6	1	1	

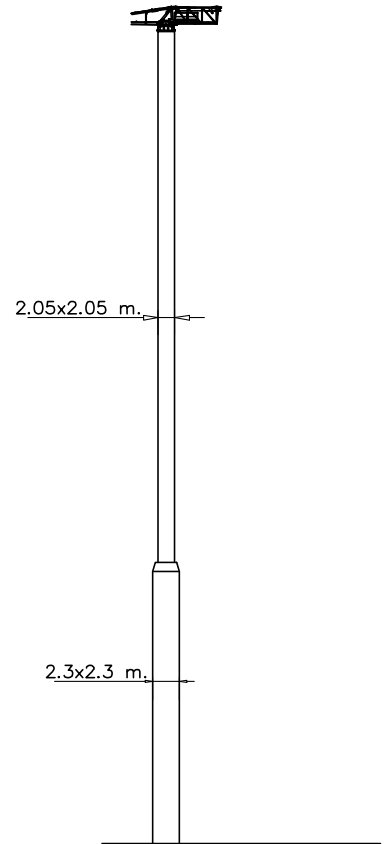

H=0-44 m		H=45-62 m	
R1	135 t	R1	174 t
R2	140 t	R2	181 t
R3	92 t	R3	119 t
M	498 tm	M	637 tm

Peso zavorra—Ballast weight—
Ballastgewicht—Peso de lastre

H	Tot.
0-44 m	102320 kg
45-62 m	132740 kg

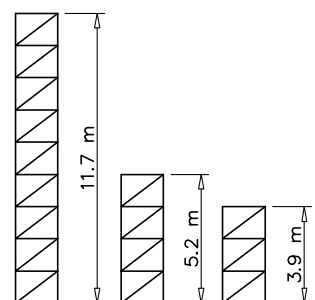

Torre/Reazioni – Masts/Reactions – Mat/Réactions – Maste/Eckdrücke – Măstil/Reacciones – Tramo/Reações

SP2300

 20 m —→ 72.7 m

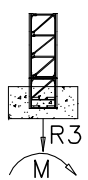
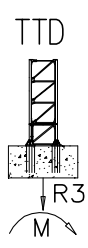
Torre/Masts/Mat/Maste/Măstil/Tramo															
	H[m]	4f/4f BF117	4f/4f BF052	4f/4f BF039	4f/4f SB117	4f/4f SB052	4f/4f SB039	4f/4f ST117	4f/4f ST052	4f/4f ST039	4f/4f STB117	4f/4f STB039	4f/4f RA039	4f/4f SBB039	4f/4f SBB117
TRO 	67.6							1	1	13					
	67.6							5	1	1					
TTD 	67.6								13						
	59.8							4	1						
	67.6 *							1	1	9	1		1		
	66.3 *								3	12			1		

Torre/Masts/Mat/Maste/Măstil/Tramo															
	H[m]	4f/4f BF117	4f/4f BF052	4f/4f BF039	4f/4f SB117	4f/4f SB052	4f/4f SB039	4f/4f ST117	4f/4f ST052	4f/4f ST039	4f/4f STB117	4f/4f STB039	4f/4f RA039	4f/4f SBB039	4f/4f SBB117
CAF 	74.1							1	1	13					
	74.1							5	1	1					
	74.1								13						
	66.3							4	1						
	74.1 *							1	1	9	1		1		
	72.8 *								3	12			1		

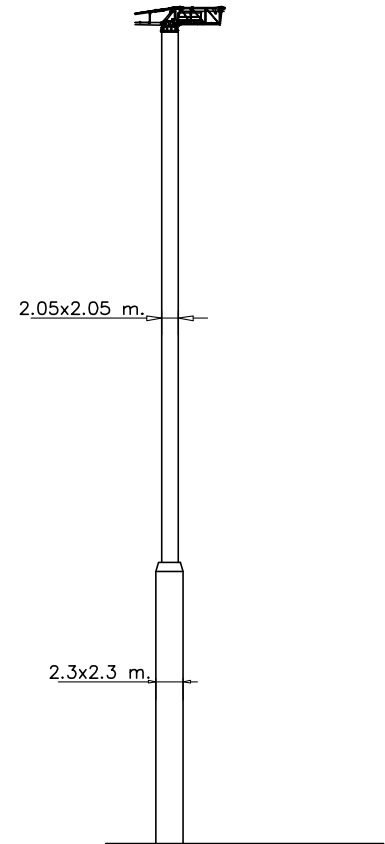

H=0–49 m		H=50–75 m	
R1	141 t	R1	181 t
R2	152 t	R2	190 t
R3	128 t	R3	160 t
M	775 tm	M	973 tm

Peso zavorra–Ballast weight–
Ballastgewicht–Peso de lastre

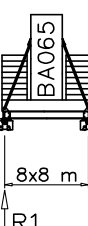



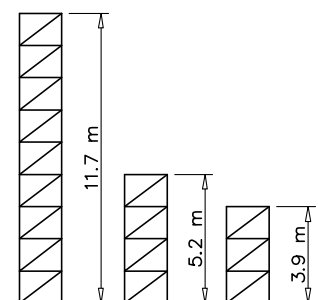

Torre/Masts/Mat/Maste/Măstil/Tramo															
	H[m]	4f/4f BF117	4f/4f BF052	4f/4f BF039	4f/4f SB117	4f/4f SB052	4f/4f SB039	4f/4f ST117	4f/4f ST052	4f/4f ST039	4f/4f STB117	4f/4f STB039	4f/4f RA039	4f/4f SBB039	4f/4f SBB117
CATR IIII CATC 	66.3							1	1	13					
	66.3							5	1	1					
	66.3								13						
	58.5							4	1						
	66.3 *							1	1	9	1		1		
	65 *								3	12			1		

H	Tot.
0–44 m	114000 kg
45–75 m	146000 kg









Curve di carico – Courbes de charges – Load diagrams – LastKurven – Curvas de cargas

Pmax 6000 kg

	21840 kg	72.7 m	2.7	22.5	25	30	35	40	45	50	55	60	65	70	72.7
			6000	6000	5600	4500	3700	3100	2650	2300	1950	1750	1550	1400	1300
	20280 kg	67.1 m	2.7		25.4	30	35	40	45	50	55	60	65	67.1	
			6000		6000	5230	4400	3800	3320	2830	2400	2050	1800	1700	
	18720 kg	61.5 m	2.7		29.8	30	35	40	45	50	55	60	61.5		
			6000		6000	5900	5200	4450	3800	3350	2950	2600	2500		
	17160 kg	55.9 m	2.7			32.8	35	40	45	50	55	55.9			
			6000			6000	5600	4850	4300	3740	3250	3100			
	15600 kg	50.3 m	2.7			33.9	35	40	45	50	50.3				
			6000			6000	5800	5150	4550	3900	3800				
	14040 kg	44.7 m	2.7					35	40	44.7					
			6000					6000	5250	4650					
	12480 kg	39.1 m	2.7					35	39.1						
			6000					6000	5300						









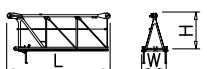
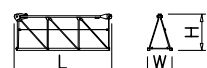
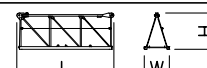

Pmax 12000/6000 kg

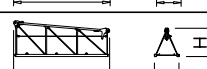
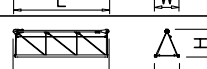
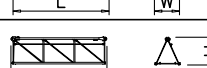
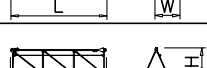
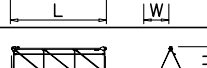

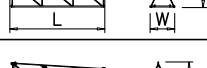
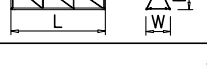

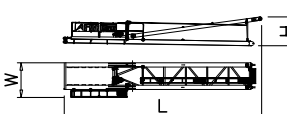
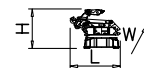

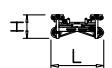
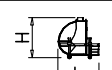
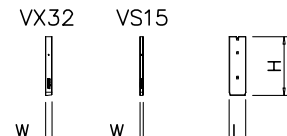



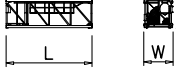
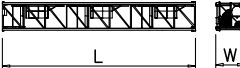

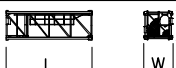
	21840 kg	72.7 m	2.7	12.5	15	20	22.5	25	30	35	40	45	50	55	60	65	70	72.7
			12000	12000	10500	7650	6000	5600	4500	3700	3100	2650	2300	1950	1750	1550	1400	1300
	20280 kg	67.1 m	2.7		13.6	15	20	25	25.4	30	35	40	45	50	55	60	65	67.1
			12000		12000	11100	9600	7000	6000	5230	4400	3800	3320	2830	2400	2050	1800	1700
	18720 kg	61.5 m	2.7		15.3	20	25	29.8	30	35	40	45	50	55	60	61.5		
			12000		12000	9500	7600	6000	5900	5200	4450	3800	3350	2950	2600	2500		
	17160 kg	55.9 m	2.7		16.5	20	25	30	32.8	35	40	45	50	55	55.9			
			12000		12000	10200	8100	6500	6000	5600	4850	4300	3740	3250	3100			
	15600 kg	50.3 m	2.7		17.3	20	25	30	33.9	35	40	45	50	50.3				
			12000		12000	10650	8800	7350	6000	5800	5150	4550	3900	3800				
	14040 kg	44.7 m	2.7				18.1	20	25	30	35	40	44.7					
			12000				12000	11000	9450	7800	6000	5250	4650					
	12480 kg	39.1 m	2.7				18.5	20	25	30	35	39.1						
			12000				12000	11200	9500	8000	6000	5300						

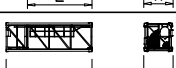

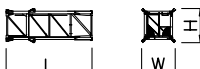
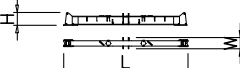
PESI E INGOMBRI – PACKING LIST – LISTE DE COLISAGE – GEWICHT UND ABMESSUNGEN

Denominazione Description	Disegno Draw	Pezzi Pieces	Dimensioni-Dimensions (mm)			Peso-Weight (kg)			
			L	W	H	Unit	Total		
Elemento di braccio Jib element Elément de èche Elemento de flecha (72.7 m. jib version)	n°13		1	6260	1540	2305	2301	–	
	n°12		1	5900	1500	2220	1597	–	
	n°11		1	5850	1500	2200	1437	–	
	n°10		1	5850	1500	2176	1230	–	
	n°9		1	5840	1500	1720	1035	–	
	n°8		1	5820	1500	1700	945	–	
	n°7		1	5800	1500	1670	803	–	
	n°6		1	5795	1500	1670	702	–	
	n°5		1	5770	1500	1630	565	–	
	n°4		1	5750	1500	1630	445	–	
	n°3		1	5735	1500	1630	370	–	
	n°2		1	5718	1500	1630	241	–	
	n°1		1	5696	1500	1280	275	–	
	Punta braccio		1	700	1200	500	55	–	
Contorbraccio completo Complete counterjib Contreflèche complète Contraflecha completa		1	11900	2100	1750	5000	–		
Gruppo girevole Slewing group Table tournante Grupo giratorio	SN2050		1	3035	2230	2370	9000	–	
	SP2300		1	3035	2230	2370	9500	–	
Carrello Trolley Chariot Carretilla	P12		1	1970	1910	815	600	–	
Ballatoio con cabina Access balcony with cabin Porte cabine Balcòn corrido con cabina		1	2500	2150	2450	1000	–		
Blocchi contrappeso Counterweight block Contre-poids Bloques de contrapeso	VX32 VS15		VS15	2	1000	200	3550	1560	3120
			VX32	6	1000	400	3550	3120	18720

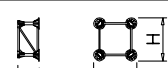
PESI E INGOMBRI – PACKING LIST – LISTE DE COLISAGE – GEWICHT UND ABMESSUNGEN

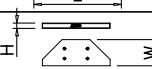
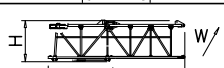
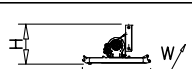
Denominazione Description	Disegno Draw	Pezzi Pieces	Dimensioni-Dimensions (mm)			Peso-Weight (kg)		
			L	W	H	Unit	Total	
Elemento di torre Mast element Elément de mât Elemento de torre	 STD039	SP2300	–	3900	2360	2360	2603	–
		SN2050	–	3900	2110	2110	2320	–
	 STD052	SP2300	–	5200	2360	2360	3198	–
		SN2050	–	5200	2110	2110	2850	–
	 STD117	SP2300	–	11700	2360	2360	6475	–
		SN2050	–	11700	2110	2110	5790	–
	 SB039	SP2300	–	3900	2360	2360	3031	–
		SN2050	–	3900	2110	2110	2710	–
	 SB052	SP2300	–	5200	2360	2360	3470	–
		SN2050	–	5200	2110	2110	3350	–
	 SB117	SP2300	–	11700	2360	2360	7830	–
		SN2050	–	11700	2110	2110	7000	–
 BF039	SP2300	–	3900	2360	2360	4210	–	
	SN2050	–	3900	2110	2110	3770	–	
 BF052	SP2300	–	5200	2360	2360	4340	–	
	SN2050	–	5200	2110	2110	3880	–	
 BF117	SP2300	–	11700	2360	2360	9150	–	
	SN2050	–	11700	2110	2110	8180	–	
Elemento di base Base element Mat de base Elemento de base		SP2300	1	6500	2360	2360	4550	–
		SN2050	1	5200	2260	2260	4040	–
Carro di base Base carriage Chassis de base Cruceta de base		8x8	1	11830	670	780	3340	3340
		6x6	1	8870	670	780	2500	2500
		8x8	2	5760	420	780	1600	3200
		6x6	2	4320	420	780	1200	2400
Puntoni di base Rafter Jambes de force Cabrios de base		8x8	4	6080	420	300	560	2240
		6x6	4	4560	420	300	420	1680
Elemento a perdere Disposable frame Chassis a perdre Bastidor desechable		SP2300	1	3000	2360	2360	2350	–
		SN2050	1	2600	2260	2260	2030	–
Elemento recuperabile Recoverable frame Chassis récupérable Bastidor recuperable		SP2300	1	1300	2900	2900	2100	–
		SN2050	1	1300	2620	2620	1860	–
Bogie di traslazione Driven bogie Boggie motorisèe Balancin de traslaciòn		4	1160	700	600	700	2800	
Blocco zavorra di base Base ballast block Lest de base Blaque de lastre		8x8	2	8300	1200	600	11900	23800
		6x6	2	6400	1200	600	10600	21200
		8x8	–	6400	1600	300	5700	–
		6x6	–	4800	2000	300	5070	–
Corsoio di montaggio Climbing cage Cage de montage Jaula de montaje		SP2300	1	8300	3250	3000	7500	–
		SN2050	1	8300	2900	2700	6700	–
Contorbraccio completo Complete counterjib Contreflèche complète Contraflecha completa		1	4100	2250	2450	5000	–	

GRU IN CAVEDIO – TELESCOPAGE SUR DALLES – CLIMBING CRANE – KLETTERKRANE IM GEBAUDE

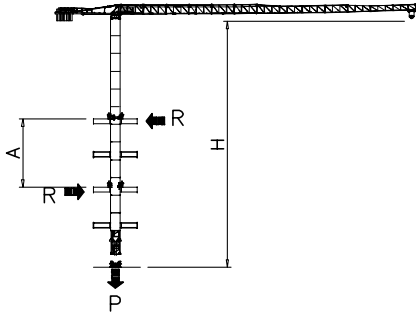

SN2050	H (m)	A (m)	R (t)	P (t)
	9	45.3		
	10	42		
	11	39.3		
	12	37		
	13	35		
	14	33.4		
	15	32		
	16	30.7		
	17	29.6		
	18	28.6		
Apertura passaggio gru Opening for crane passing 	19	27.8		
	20	27		

* SOPRALZO IDRAULICO – TELESCOPABLE – EXTERNAL CLIMBING – KLETTERKRANE

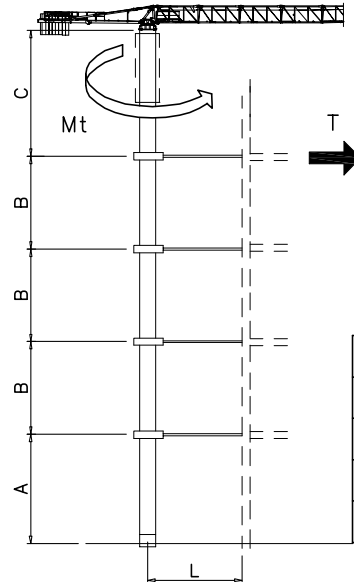
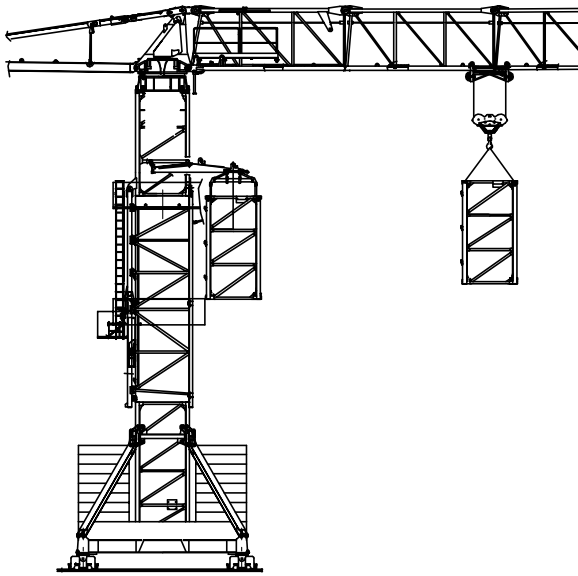

	SP2300	SN2050
C	31.2 m	31.2 m.
B	19.5 m	19.5 m
A	56 m	50 m
T	23.4 t	27.5 t
MT	26 t xm	26 t xm

Montaggio – Montage – Erection – Montage – Montaje – Montagem

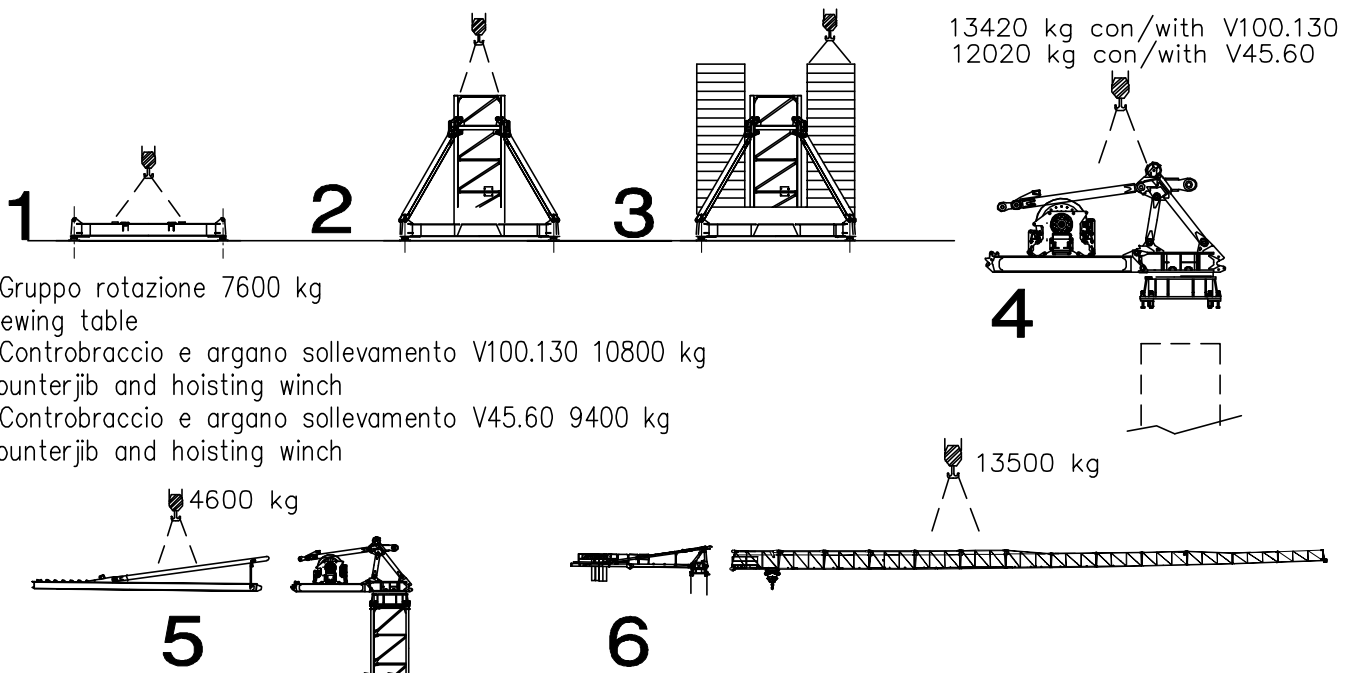

- Gruppo rotazione 7600 kg
Slewing table
- Controbraccio e argano sollevamento V100.130 10800 kg
Counterjib and hoisting winch
- Controbraccio e argano sollevamento V45.60 9400 kg
Counterjib and hoisting winch

Meccanismi – Mechanisms – Mécanismes – Antriebe – Mecanismos

Sollevamento V45.60 Hoisting Levage Heben Elevaciòn Elevaçao														V45.60 33 kW 57 kVA 270 m 500 m (L)
	m/min	3	14	30	45	60	72	1.5	7	15	22.5	30	36	
	t	6	6	6	3.5	2.4	1.4	12	12	12	7	4.8	2.8	
Sollevamento V75.100 Hoisting Levage Heben Elevaciòn Elevaçao														V75.100 55 kW 78 kVA 270 m 570 m (L)
	m/min	4	20	48	64	78	95	2	10	24	32	39	47.5	
	t	6	6	6	4.2	3.2	1.9	12	12	12	8.4	6.4	3.8	
Sollevamento V100.130 Hoisting Levage Heben Elevaciòn Elevaçao														V100.130 75 kW 110 kVA 360 m 750 m (L)
	m/min	6	28	54	86	115	130	3	14	27	43	57	65	
	t	6	6	6	4	2.8	1.4	12	12	12	8	5.6	2.8	

Carrello Trolleying Distribution Katzfahren Distribuciòn Distribuiçao			0 → 110	m/min	5.5 kW	Potenza elettrica necessaria Puissance électrique nécessaire Necessary electric power Anschlusswert – Potencia
Rotazione Slewing Orientation Schwenken Orientaciòn Rotaçao			0 → 0,9	giri/min tr/min rp/min	12 kW @ 1200rpm n° 3 x 4 kW	
Traslazione Travelling Translation Kranfahren Traslaciòn Traslaçao			0 → 20	m/min	9 kW	

Rete elettrica – Réseau – Mains supply – Netzstrom – Red – Rede electrica	400V – 50 Hz
---	--------------

AFM Gru s.r.l.
via Emilia 11-29010 Pontenure PC ITALY
tel. 0523/510446 ric.aut. fax 0523/510365
www.fmgru.it e-mail: info@fmgru.com

FEM 1.001
2000/14/CE



Documento commerciale non contrattuale
Per tutte le informazioni tecniche riferirsi
alle corrispondenti istruzioni

Unverbindliches Vertriebsdokument.
Für technische Informationen, siehe die
entsprechenden Anweisungen.

This commercial document is not legally
binding. For any technical information, please
refer to the corresponding instructions.

Documento comercial non contrattuale
Para cualquier información técnica,
ver la noticia correspondiente.

Code: 15ICA37T62A0
Ed. Data Rev Data
1 25.03.01 2 25.02.10